

65W DALI DT8 NFC Enabled LED Driver(Constant Current)

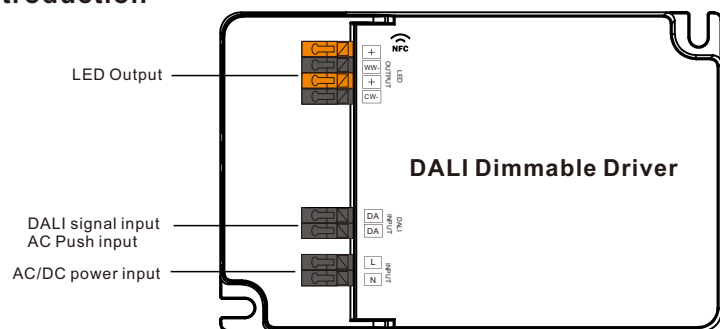

Important: Read All Instructions Prior to Installation

Function introduction



Product Data

Output	LED Channel	2
	DC Voltage	6-54V
	Current	500-1500mA via NFC tool; Min.current gear lower to 0.1mA, default 1050mA
	Current Accuracy	±3% (±1% @ Certain full load) @ full load
	Rated Power	Max. 65W
Input	Voltage Range	200-240VAC/200-240VDC
	Absolute Voltage Range	176-264VAC/176-280VDC
	Frequency Range	0/50/60Hz
	Power Factor (Typ.)	> 0.98 @ 230VAC Full load
	Total Harmonic Distortion	THD ≤ 6% (@ full load / 230VAC)
	Efficiency (Typ.)	> 90% @ 230VAC full load
	AC Current (Typ.)	0.35A @ 230VAC
	Inrush Current (Typ.)	Max. 9.68A at 230VAC; 70µs duration
	Leakage Current	< 5mA /230VAC
	Standby Power Consumption	< 0.5W
Control	Anti Surge	L-N:2KV
	Dimming Interface	DALI Device Type 8 (DALI consumption < 2mA)/ AC Push
	Dimming Range	0.01%-100% @ Max current
	Dimming Method	Amplitude/CCR dimming
	Dimming Curve	Linear/ Logarithmic optional

Protection	Short Circuit	Yes, remove the fault conditions and re-power the device.
	Over Current	Yes, remove the fault conditions and re-power the device.
	Over Temperature	Yes, remove the fault conditions and re-power the device.
Environment	Working Temp.	-25°C ~ +45°C
	Max. Case Temp.	Tc=85°C
	Working Humidity	10% ~ 95% RH non-condensing
	Storage Temp. & Humidity	-40°C ~ +80°C, 10% ~ 95% RH
Safety & EMC	Safety Standards	EN61347-1, EN61347-2-13
	Withstand Voltage	I/P-O/P: 3.75KVAC
	Isolation Resistance	I/P-O/P: 100M Ohms / 500VDC / 25°C / 70% RH
	EMC Emission	En55015, EN61000-3-2, EN61000-3-3
	EMC Immunity	En61547, EN61000-4-2,3,4,5,6,8,11
Others	MTBF	191350H, MIL-HDBK-217F @ 230VAC full load and 25°C ambient temperature
	Dimension	123.9x78.8x30mm (L*W*H)
	Warranty	5 Years

- In compliance with IEC 62386-101:2014, IEC 62386-102:2014, IEC 62386-207 Ed2, IEC 62386-209:2011
- Built-in DALI-2 interface, DALI DT8 device
- Dimmable LED driver. Max. output power 65W
- 500-1500mA current selectable via NFC program tool. Min.current gear lower to 0.1mA
- DALI Address/Group/Scene setting via NFC program tool.
- Class II power supply, full isolated plastic case
- High power factor and efficiency
- ON/OFF, Dimming and Tunable White control
- Amplitude/CCR dimming, smooth and deep dimming
- Compatible with universal DALI masters that support DT6 commands
- Error report function
- IP20 rating, suitable for indoor LED lighting applications
- 5 years warranty

Safety & Warnings

- DO NOT install with power applied to the device.
- DO NOT expose the device to moisture.

Operation

With DALI master

1. DALI Address

1 DALI address for 2 channels output are assigned by DALI Master controller automatically, please refer to user manuals of compatible DALI Masters for specific operations.

With NFC Programming devices

Note

1) Do wiring according to the wiring diagram and power on the DALI system .

2) Recommend setting parameters without power-on the DALI devices .

2) Please make sure your mobile phone has NFC function and enable it .

Working with “SR NFC Tool” APP

Step 1: Download the APP (searching “SR NFC Tool” from App Store and Google Play) . Then open the APP .

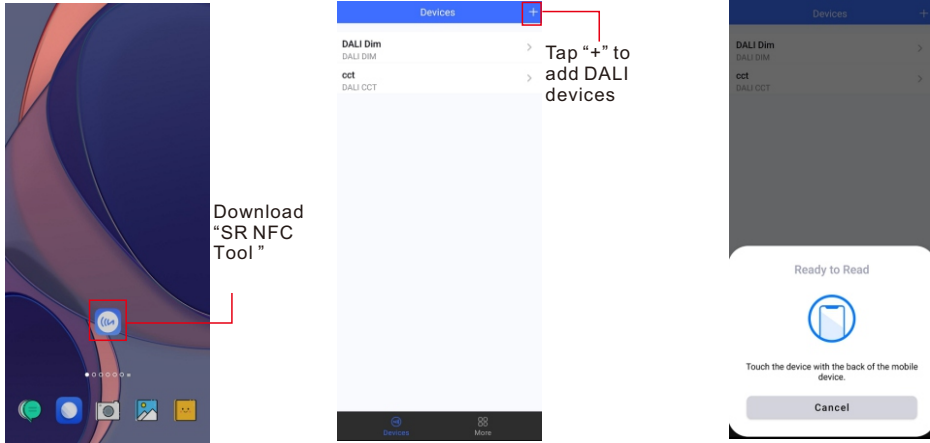

- Note:**
1. Please Make sure that you have enabled NFC function with your mobile phone/ tablet .
 2. Please Make sure that the “NFC position” is matched.
 3. Please do not power on the device before setting.
 4. If you can't download “SR NFC Tool”. Please contact with us.

Step 2: Add device, and name it as you wish.

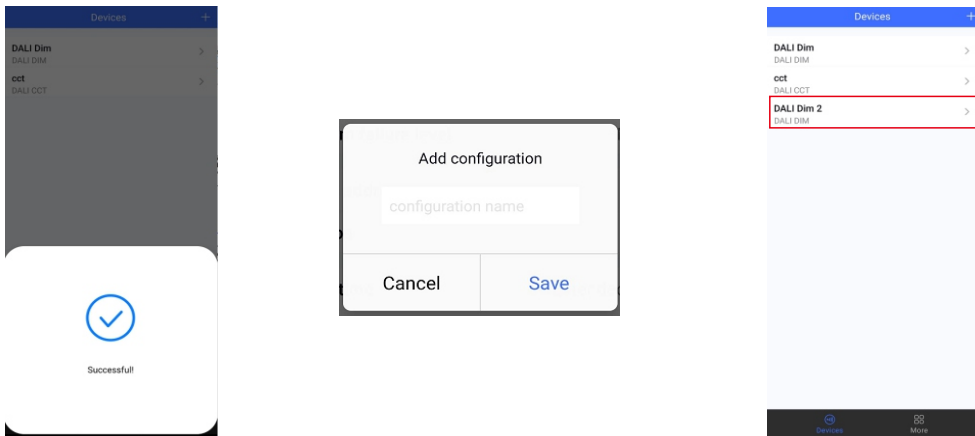

Step 3: Unlock device, enter parameters configuring page.

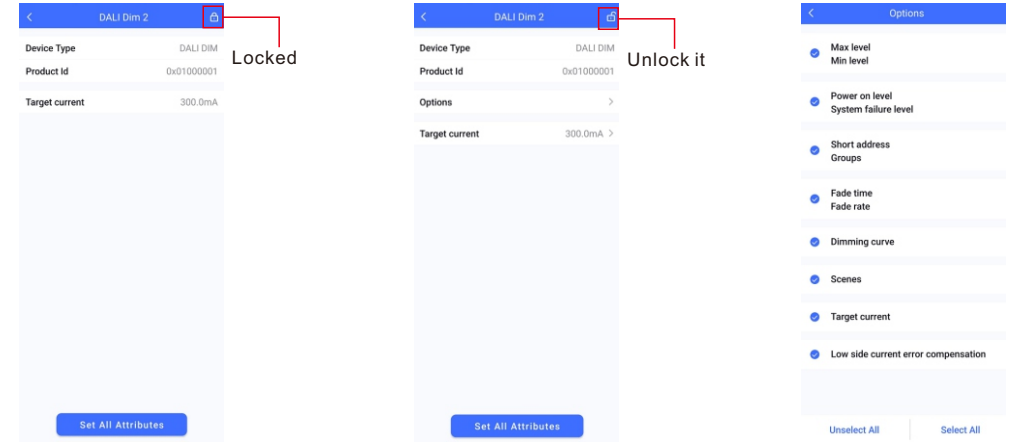

- Note:**
1. You have to unlock the device then do some settings
 2. Only when the corresponding function is selected, the function interface will be displayed.

Step 4: Few parameter interface, you can choose the setting based on your requirements.

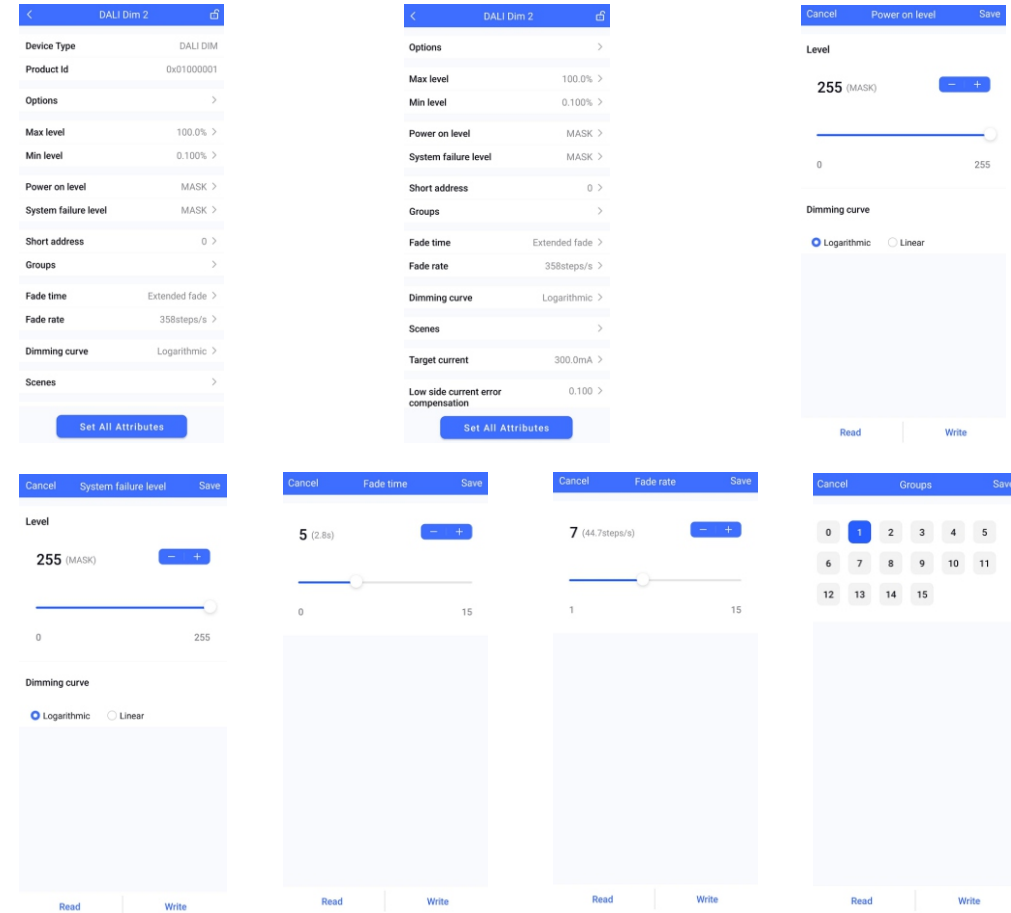

Step 5: After setting, please save the selected configuration via NFC and power on the device.



Tips

1. NFC function doesn't require any power driver.
2. Many functions can be configured by NFC. Kindly check your desired functions.
3. All of our DALI drivers are in the best performance within our DALI master/ DALI IoT gateway.
4. This is a 2-channel output product, so we recommend ensuring that both loads are connected and have the same loads for each channel at the same time during testing.
 - 4.1 If you have to connect 1 channel to test, please follow the following moves (before powering on).
 - 4.1.1 If you are connected to "+/WW" (signal channel), please make sure to set "power on CCT" of NFC Driver to 2700k (DALI default value), and write to the device.
 - 4.1.2 If you are connected to "+/CW" (signal channel), please make sure to set "power on CCT" of NFC Driver to 6500k (DALI default value), and write to the device.

CLO AND CORRIDOR DIM(CD) FUNCTION INSTRUCTION

1. Open APP, and Find the CLO/CD functions

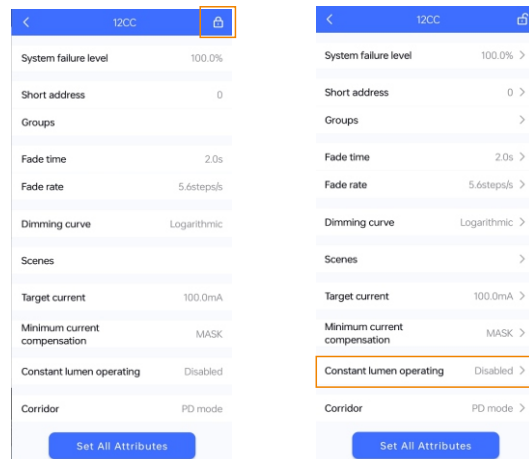

Read From the NFC Driver

Unlock it, and Click here to enter CLO settings

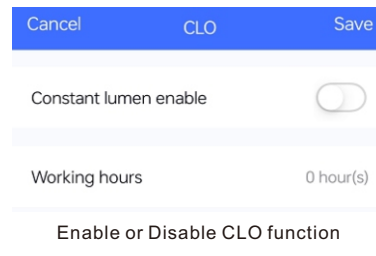

2. Enter CLO Setting homepage

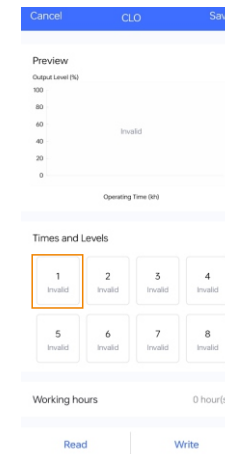

Enable CLO function

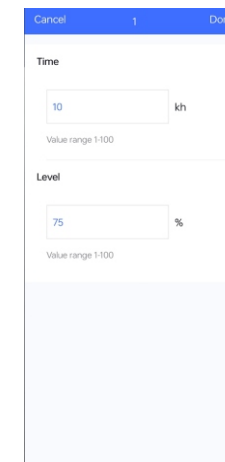

Click "1", and set its time and level

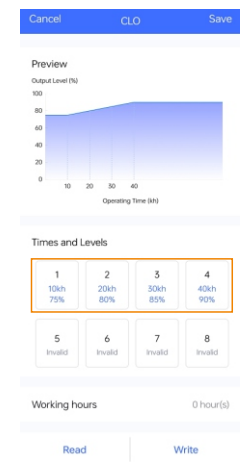

Set your desired time and levels. Graphic display

Tips:

Working hours : Ability to calculate the working hours of a single driver.

Additional Remarks

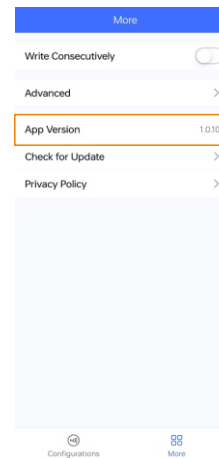

1. Please make sure your APP version is 1.0.10 or higher.
2. Please make sure NFC driver's firmware is available with CLO functions.

Wiring Diagram

1. With DALI bus

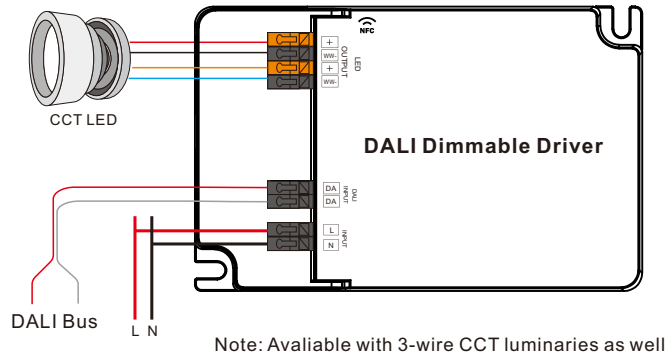

2. With PUSH dimmer

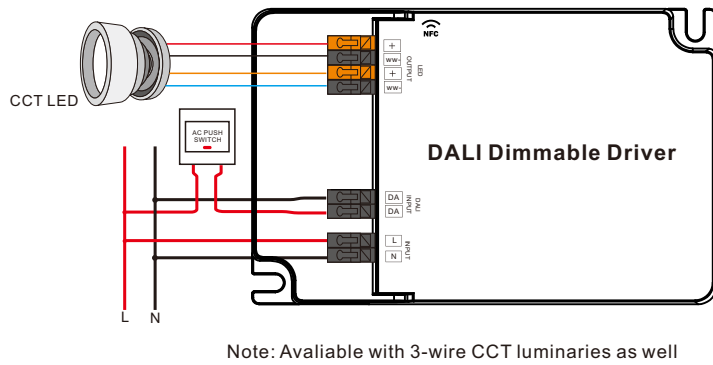

AC Push Function

- 1) Click the button to switch ON/OFF
- 2) Press and hold down the button to increase or decrease light intensity to desired level and release it, then repeat the operation to adjust light intensity to opposite direction. The dimming range is from 1% to 100%.

Product Dimension

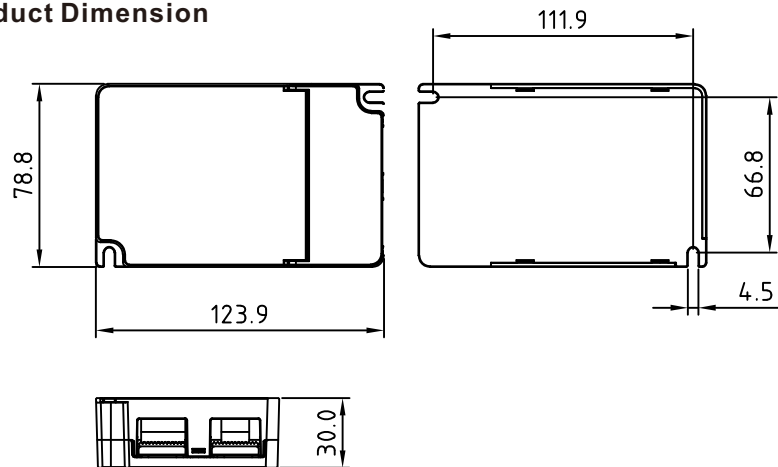

Operating window

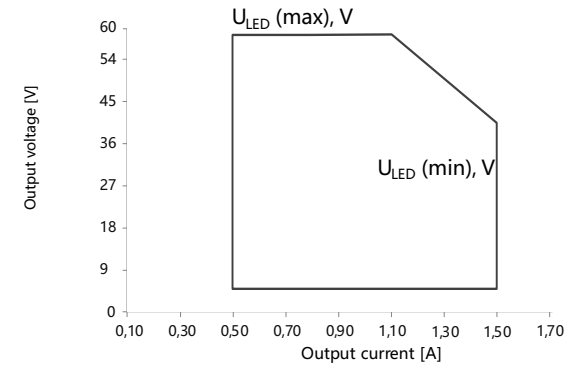

Dimming Curve

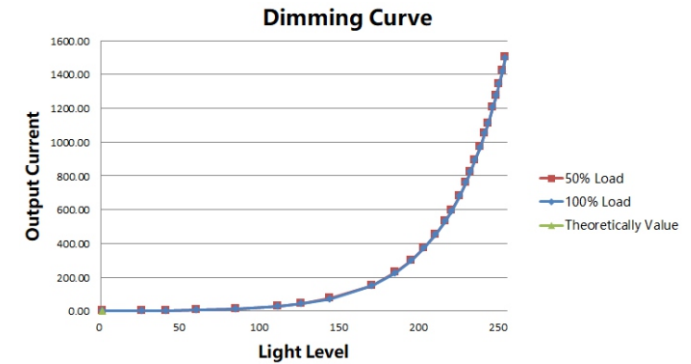

Note: Test data under 1500mA gear

Driver Performance

Typical Power Factor

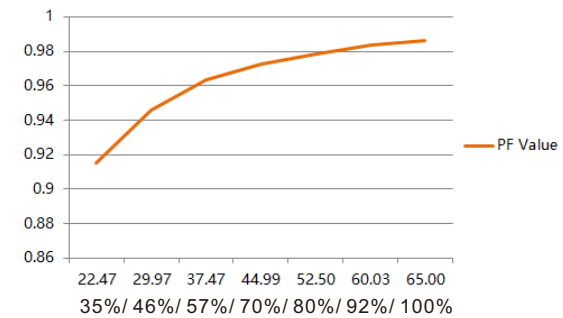

Note: Test data under 1500mA gear

Driver Performance

Typical Efficiency

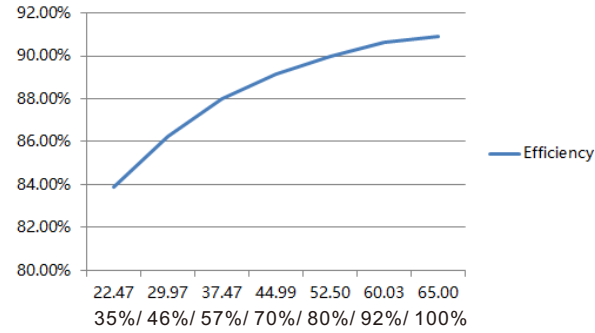

Note: Test data under 1500mA gear

Driver Performance

THD VS Load

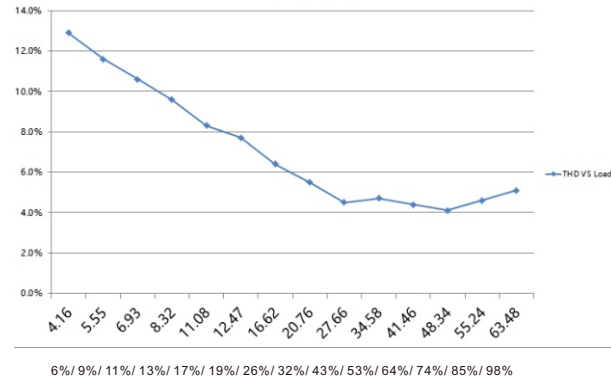

Note: Test data under 1500mA gear

Expected Lifetime

Module Number	Output current	Ta	30 °C	40 °C	45 °C	•••
SRP-2305N-65CC500-1500	500 – 1500 mA	Tc	50 °C	60 °C	68 °C	••• 85 °C
SRP-2309N-65CCT500-1500	500 – 1500 mA	Lifetime	> 100,000 h	> 100,000 h	> 100,000 h	> 40,000 h

The LED driver is designed for a lifetime stated above under reference conditions .
The relation of tc to ta temperature depends also on the luminaire design.

MCB Load Quantity

Module Number	Ipeak	Twidth	Max.quantity of LED Driver per MCB														
			B10	B13	B16	B20	B25	C10	C13	C16	C20	C25	D10	D13	D16	D20	D25
SRP-2305N-65CC500-1500	9.68A	70µs	15	20	24	30	38	20	26	32	40	50	22	29	36	45	57
SRP-2309N-65CCT500-1500	9.68A	70µs	15	20	24	30	38	20	26	32	40	50	22	29	36	45	57

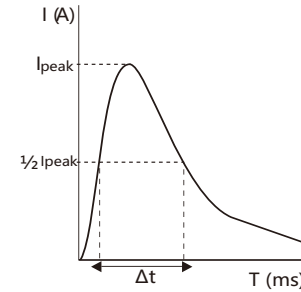

Note:

- 1.Those MCB parameters are based on ABB S200 series circuit breakers.
- 2.For different brands and models of miniature circuit breakers, the quantity of drivers will have difference.
- 3.Please do not exceed the above-mentioned quantity during on-site installation, and the specific load quantity shall be subject to on-site installation.
- 4.When the installation environment temperature of MCBs exceeds 30°C or when multiple MCBs are installed side by side, the number of mounted drives will be reduced, which requires recalculation.
- 5.Type C MCB's are strongly recommended to use with LED lighting

Update log

Date	Version	Update content	Update by
2023-6-19	V1.4	Update CLO function	Romeo

Note: Subject to change without notice. Please contact us if you have any questions.